

Create Your Customized Style Number :

CD

STEP 1 Enter Your Seat Cushion Style Number STEP 2* Enter Your Style/Length Number STEP 3 Enter Your Arm Style Number *STEP 2 cont. Enter Your Style/Length Number Extension (if applicable - up to 2 digits)



Simply follow the steps below to create your Customized Style Number, select your back cushions and base styles, then choose from our selection of fine fabrics to complete your own custom design order.

Step 1: Seat Cushion Style

choose either a T-Cushion Style or Square Cushion Style

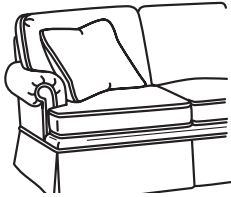

86 : T-Cushion

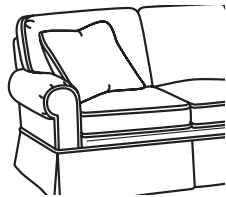

87 : Square Cushion

Step 2: Style/Length

choose a style/length...sofa, chair, etc. from the grid below

Custom Design Series Dimensions*

Overall Height:	38 in.	Seat Height:	21.5 in.
Overall Depth:	38 in.	Seat Depth:	22 in.
Arm Height:	25.5 in.	Back Rail Height:	30.5 in.

*Note: Most style lengths are shortened when a Track Arm or English Arm is chosen; these lengths are denoted with a 'T' for Track Arm and an 'E' for English Arm. If a style has a dashed extension, you should put this at the end of your style number.

 04 : Loveseat	 CD8607 : Ottoman	 10-L : Left Arm Corner Sofa	 10-R : Right Arm Corner Sofa
 02 : Short Sofa with 2 cushions	 05 : Chair	 11-L : Left Arm Sofa	 11-R : Right Arm Sofa
 00-2 : Long Sofa with 2 cushions	 05-SW : Swivel Chair	 12 : Corner Chair	 14-L : Left Arm Loveseat
 00-2S : Sleeper with 2 cushions	 14-R : Right Arm Loveseat	 13 : Curve	 09-L : Left Arm Chaise
 00 : Long Sofa with 3 cushions	 09-R : Right Arm Chaise	 15 : Armless Chair	 16 : Armless Loveseat
 03 : Wedge Sofa	 8703R - 53" 8703S - 53" 8703P - 53"		

Step 2: Style/Length (... continued)

choose a style/length...sofa, chair, etc. from the grid below

Custom Design Deep Series Dimensions*

Overall Height:	38 in.	Seat Height:	21.5 in.
Overall Depth:	41 in.	Seat Depth:	24.5 in.
Arm Height:	25.5 in.	Back Rail Height:	30.5 in.

SAME STYLES
DEEPER VERSION

***Note:** Most style lengths are shortened when a Track Arm or English Arm is chosen; these lengths are denoted with a 'T' for Track Arm and an 'E' for English Arm. If a style has a dashed extension, you should put this at the end of your style number.

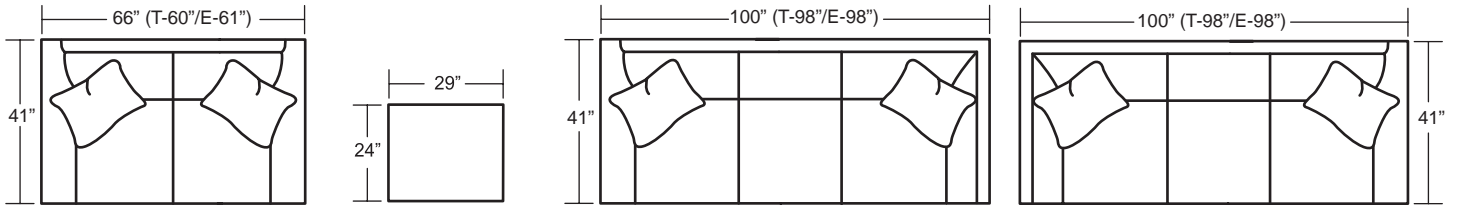

24 : Loveseat

CD8607 : Ottoman

30-L : Left Arm Corner Sofa

30-R : Right Arm Corner Sofa

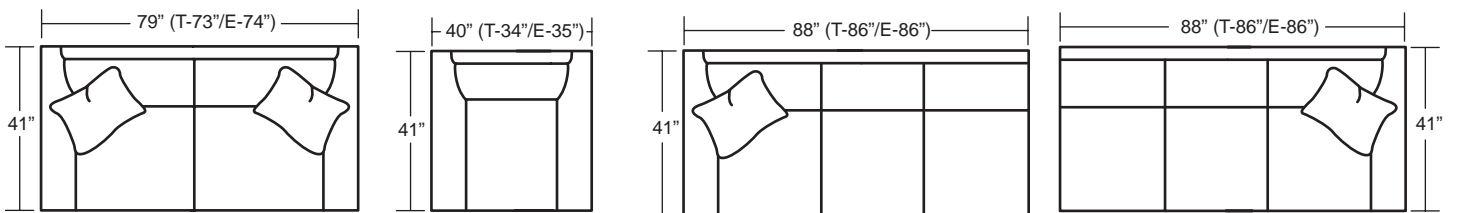

22 : Short Sofa with 2 cushions

25 : Chair

25-SW : Swivel Chair

31-L : Left Arm Sofa

31-R : Right Arm Sofa

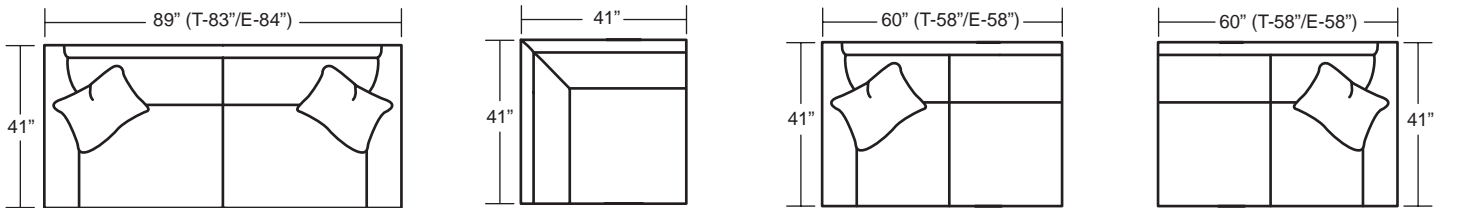

20-2 : Long Sofa with 2 cushions

32 : Corner Chair

34-L : Left Arm Loveseat

34-R : Right Arm Loveseat

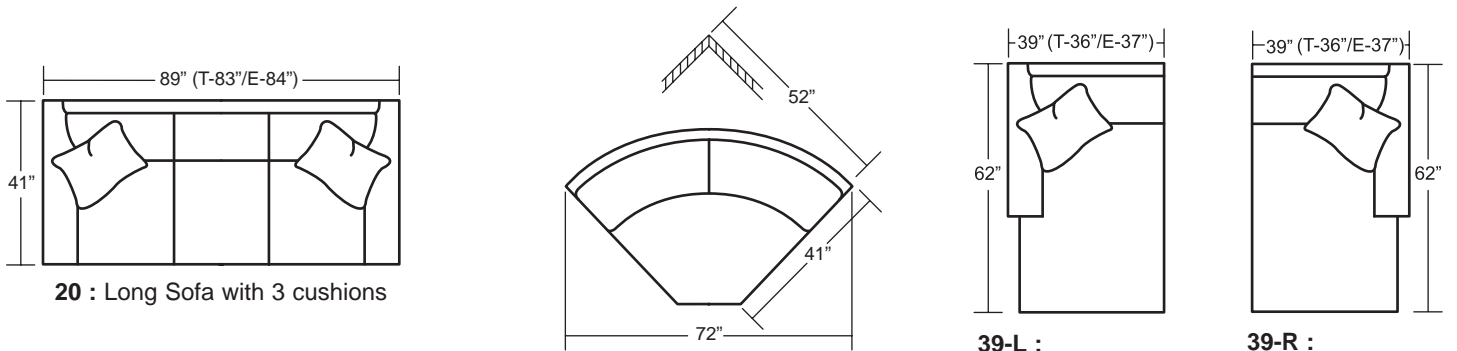

20 : Long Sofa with 3 cushions

33 : Curve

39-L :
Left Arm Chaise

39-R :
Right Arm Chaise

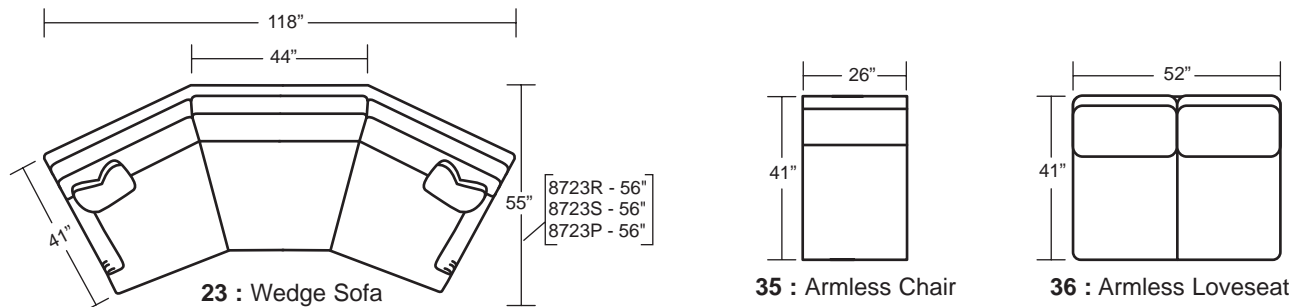

23 : Wedge Sofa

35 : Armless Chair

36 : Armless Loveseat

Step 3: Arm Style

choose one of the arm styles shown below

(English Arm only available with T-Cushion)

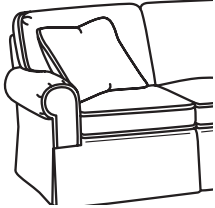

S : Sock Arm

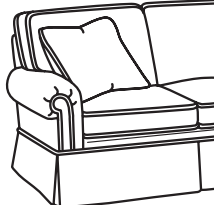

R : Roll Panel Arm

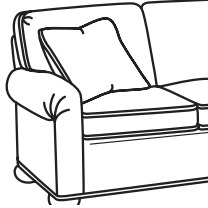

P : Pleated Arm

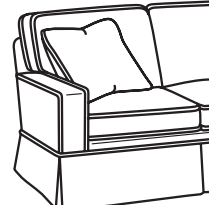

T : Track Arm



E : English Arm

Step 4: Back Cushion Style

choose either knife edge or box border cushion, then choose if the back cushion should be loose or semi-attached

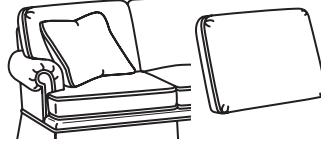

- Knife Edge Back Cushion**
(Single welt with pleated corners)
- Loose** **Semi-Attached**

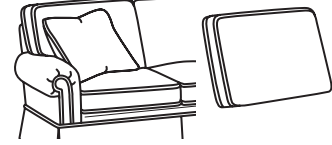

- Box Border Back Cushion**
(5" Border between two welts)
- Loose** **Semi-Attached**

Step 5: Base Style

choose a base style and wood finish (if applicable)



Kick Pleat Skirt

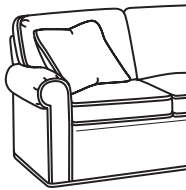

Upholstered

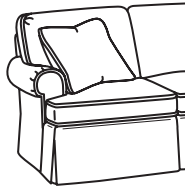

Draped Skirt *
*see price list for additional charge

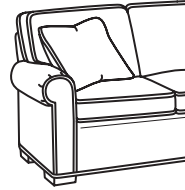

Block Feet *
*Please specify Finish on your order

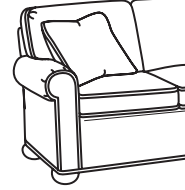

Bun Feet *
*Please specify Finish on your order

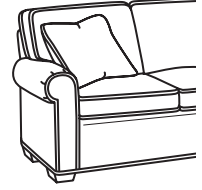

Wedge Feet *
*Please specify Finish on your order

ORDER NO. _____

Submit Orders To: PO BOX 2128
HICKORY, NC 28603
FAX 828.328.4523



CUSTOMER P.O.# _____

DATE _____

SOLD TO _____

SHIP TO _____

TERMS: _____ F.O.B FACTORY: _____

WHEN: _____ SHIP VIA: _____

CONTACT NAME : _____

CONTACT PHONE: _____

QUAN:	STYLE NUMBER	FINISH	DESCRIPTION	UNIT PRICE	TOTAL
	CD _____				
TOTAL					

Inasmuch as upholstering fabrics are not guaranteed by the Mills, we will not be held responsible for wear or fading of any covering materials. All orders accepted subject to increased costs arising out of operation of National Industrial Act or other factors beyond the seller's control. Reasonable notice of any increase shall be given purchaser before shipment. No cancellation will be taken on this order if covers have been cut. All Conditions must be expressed in writing. No verbal agreement will be recognized. All orders subject to acceptance by the Company. All contracts contingent on strikes, fires and other causes beyond our control.

PURCHASER _____ SALESMAN _____