







ASSEMBLY INSTRUCTION

Item#:5281-10458 Mirrored Writing Desk

** Please make sure you have all parts indicated below prior to assembly.

NO	HARDWARE LIST		Q'TY
A		5/16" FLAT WSAHER	14
B		5/16" LOCK WSAHER	14
C		5/16*40mm BOLT	12
D		ALLEN WRENCH	1
E		METAL ROSETTE	2
F		5/16*60mm BOLT	2

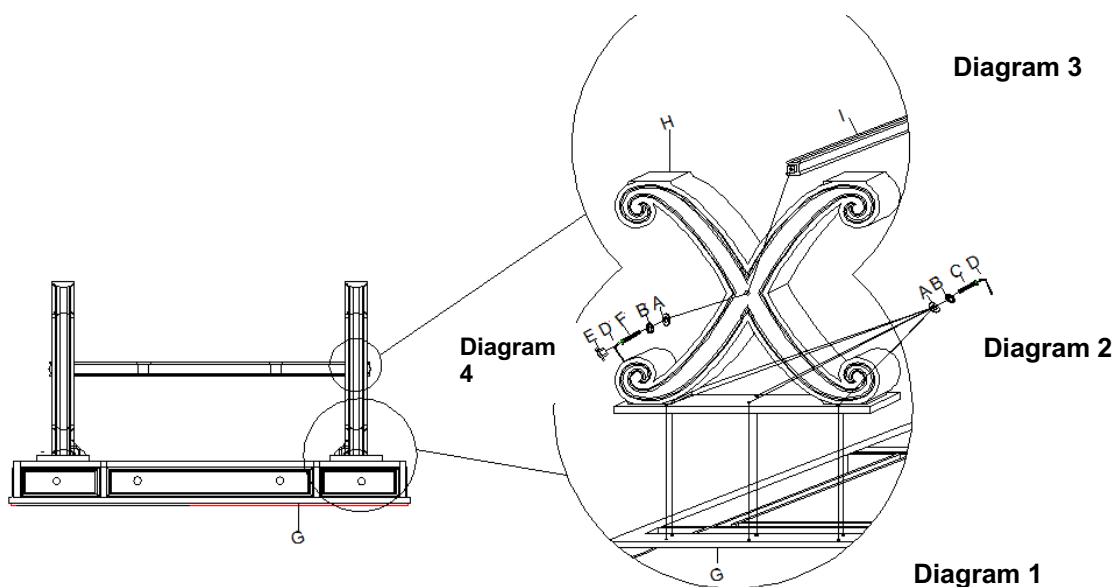
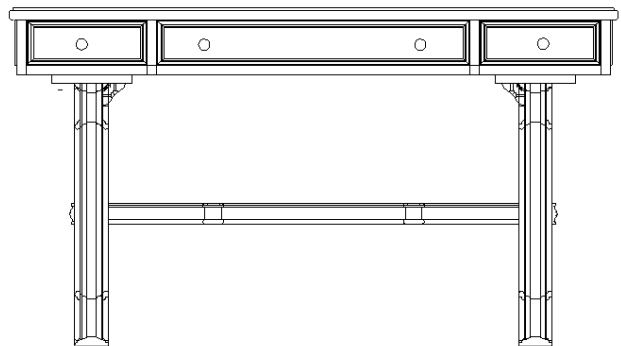

ASSEMBLY STEPS:

1. Put desk top(G) upside down on a soft surface to prevent it from being scratched. (See diagram 1)
2. Attach end pedestal (H) onto desk top(G) by using bolt(C), lock washer(B) and flat washer(A). Don't tighten them right now. Repeat this step to attach the other end pedestal(H) to desk top (G). (See diagram 2)
3. Place bottom stretcher(I) between two end pedestals (H). Use bolt (F), lock washer (B) and flat washer to make it secure with allen wrench. (D) (See diagram 3)
4. Use allen wrench (D) to make bolts (C) secure. Insert metal rosettes (E) into the holes of end pedestal (H) and press them tight. (See diagram 4)
5. Turn desk upright.

Cleaning Instruction: Clean finished parts with a damp cloth using a mild dishwashing liquid and water solution. Polish the finish with soft cloth and an industry recognized furniture polish.