





# ASSEMBLY INSTRUCTION

Item#: 5291-75001 Dining Base (C)  
5291-75002 54in Top w/1-20in Leaf (C)

\*\* Please make sure you have all parts indicated below prior to assembly.  
This top is heavy and can best be assembled with the help of two or more persons.

NO.	HARDWARE LIST		Q'TY
A		ALLEN WRENCH	1
B		BOLT	4
C		LOCK WASHER	4
D		FLAT WASHER	4

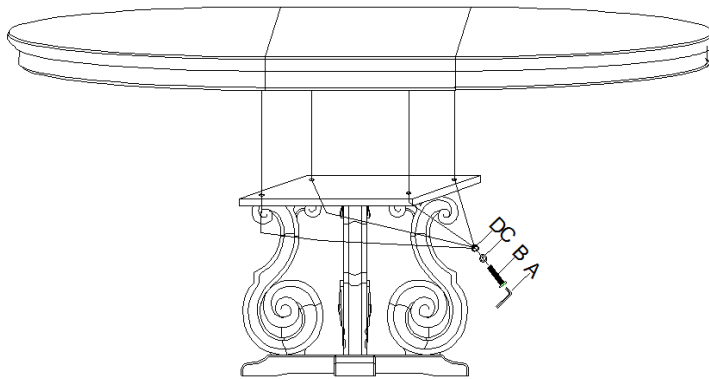
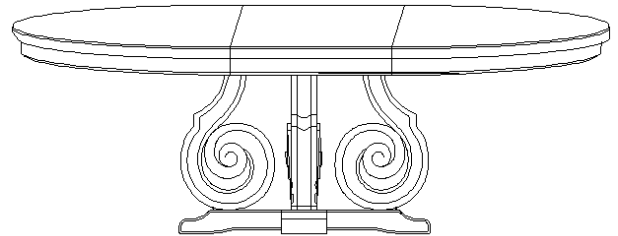

## Assembly Steps:

Screw the table top and base by using 4 bolts (B), 4 lock washers (C) and 4 flat washers (D) tightly with allen wrench (A) in clockwise direction. (See Diagram 1)

Diagram 1

## Instruction for table leaf:

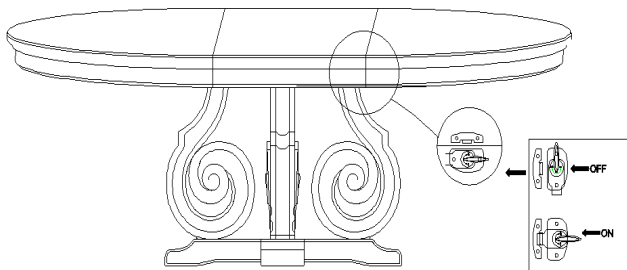

Diagram 2

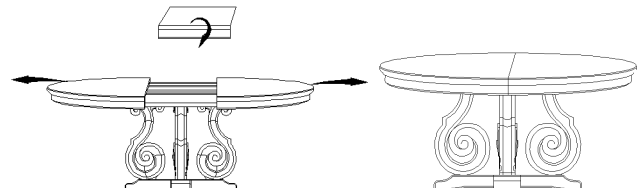

Diagram 3

1. If you want to remove leaf from the top, please turn the switch to "off" position underneath the top panel (See Diagram 2).
2. Pull out two ends of top panel and remove leaf away, then push top panel together and turn the switch to "on" position (See Diagram 3). Take opposite actions to place table leaf back.

**Cleaning Instruction:** Clean finished parts with a damp cloth using a mild dishwashing liquid and water solution. Polish the finish with soft cloth and an industry recognized furniture polish.