









# ASSEMBLY INSTRUCTION

ITEM: 5750-75203B-MWD Ascension Round Dining Table Base  
 5750-75203T-MWD Ascension 48in Wood Round Dining Table Top  
 5750-75213T-MWD Ascension 60in Wood Round Dining Table Top  
 5750-75203T-SLV Ascension 48in Zinc Round Dining Table Top  
 5750-75213T-SLV Ascension 60in Zinc Round Table Top

Thank you for purchasing this quality product. Be sure to unpack carefully looking for small parts which may have come loose during shipment.  
 Read all instruction and study the drawing carefully before starting the assembly process.

**HARDWARE PACK**

**PART LIST**

NO.	DRAWING	DESCRIPTION	SIZE	Q'TY	NO.	DRAWING	DESCRIPTION	Q'TY
A		Flat Washer	5/16"	4PCS	①		Top	1PC
B		Lock Washer	5/16"	4PCS	②		Mounting Bridge	1PC
C		Bolt	5/16*45mm	4PCS	③		Extension Block	1PC
D		Allen Wrench	73*29*5mm	1PC	④		Base	1PC

**Note:**

1. Mounting bridge (2) cannot be assembled upside down, please follow numbers on mounting bridge (2) and top of the base (4) when assemble.
2. Heights (30"-36") of this table are adjustable by adding or removing the extension block (3).

Assembly steps (with extension block, 36" height):

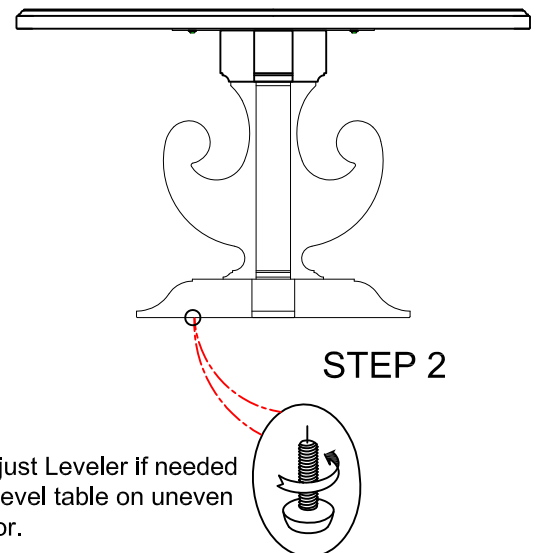
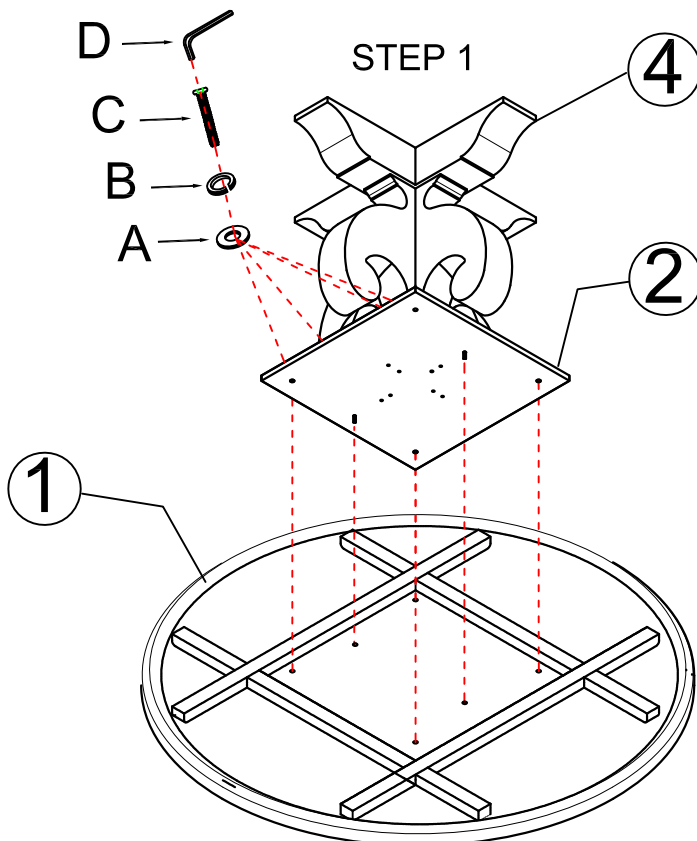

# ASSEMBLY INSTRUCTION

ITEM: 5750-75203B-MWD Ascension Round Dining Table Base  
 5750-75203T-MWD Ascension 48in Wood Round Dining Table Top  
 5750-75213T-MWD Ascension 60in Wood Round Dining Table Top  
 5750-75203T-SLV Ascension 48in Zinc Round Dining Table Top  
 5750-75213T-SLV Ascension 60in Zinc Round Table Top

Thank you for purchasing this quality product. Be sure to unpack carefully looking for small parts which may have come loose during shipment.  
 Read all instruction and study the drawing carefully before starting the assembly process.

Assembly steps (without extension block, 30" height):

