







ASSEMBLY INSTRUCTION

ITEM: 5960-75903-MULTI Dripping Springs Island

Thank you for purchasing this quality product. Be sure to unpack carefully looking for small parts which may have come loose during shipment.

Read all instruction and study the drawing carefully before starting the assembly process.

HARDWARE PACK				
NO.	DRAWING	DESCRIPTION	SIZE	Q'TY
A		Bolt	Ø5/16"*40mm	2PCS
B		Flat Washer	Ø5/16"*16mm	2PCS
C		Lock Washer	Ø5/16"	2PCS
D		Allen Wrench	73*29*5mm	1PC
E		Anti - Tip Kit		1PC

PART LIST			
NO.	DRAWING	DESCRIPTION	Q'TY
1		Hooks	1 Set of 5PCS

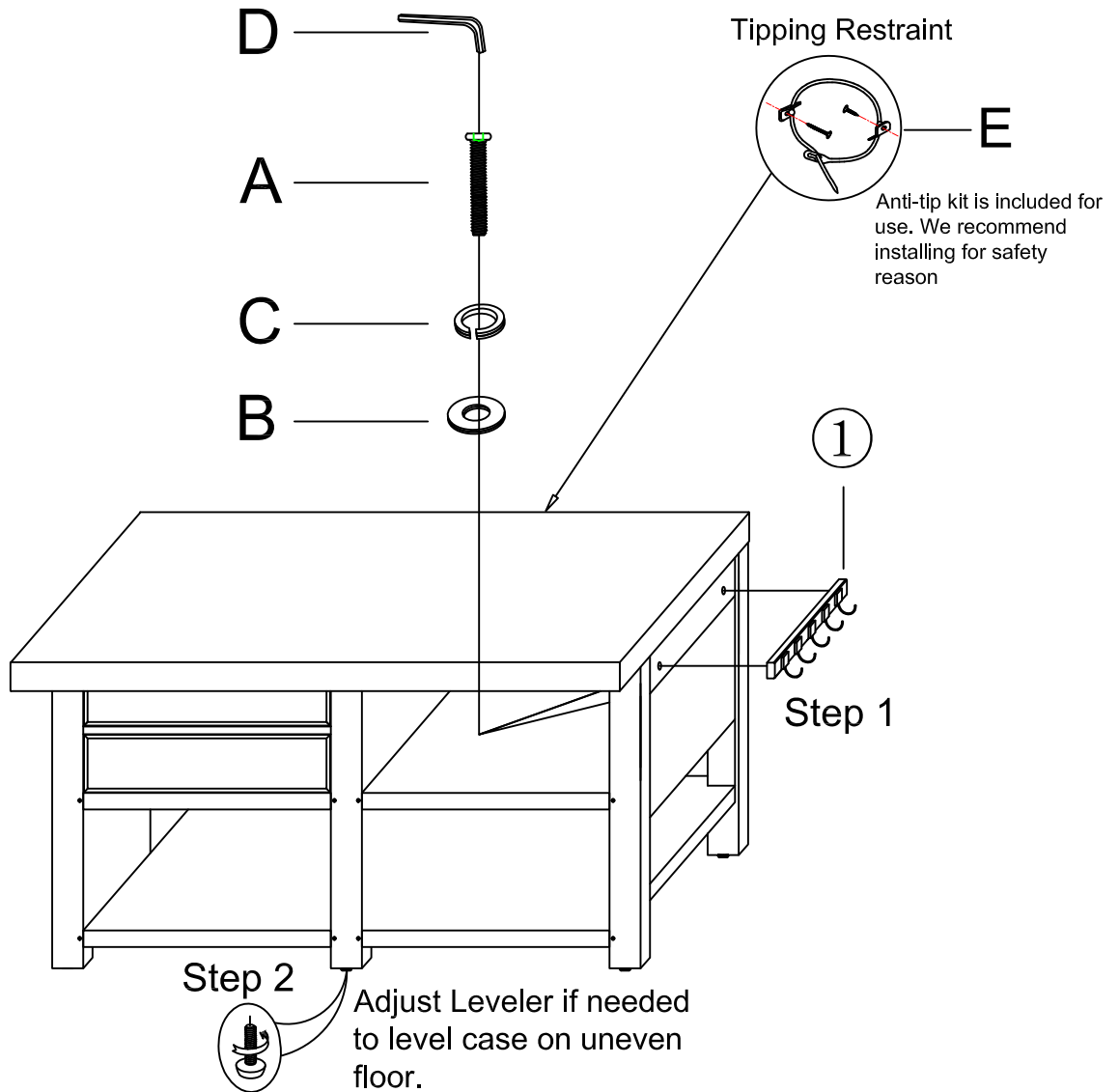

Note: Anti-tip kit restraint is provided. Please follow the instructions enclosed with the pack.