



















ITEM: 6025-75206B-90 Ponte Friendship Table Base
 6025-75206T-90 Ponte 60in Friendship Table Top w/ 2-12in Leaves

Thank you for purchasing this quality product. Be sure to unpack carefully looking for small parts which may have come loose during shipment.
 Read all instruction and study the drawing carefully before starting the assembly process.

HARDWARE PACK

NO.	DRAWING	DESCRIPTION	SIZE	Q'TY
A		Flat Washer	Ø5/16"	24PCS
B		Lock Washer	Ø5/16"	24PCS
C		Bolt	5/16*40mm	12PCS
D		Allen Wrench	73*29*5mm	1PC
E		Bolt	Ø5/16**100mm	4PCS
F		Threaded Rod	5/16*130mm	4PCS
G		Nut	Ø5/16"	4PCS
H		Open Wrench	Ø5/16"	1PC
I		Curved Washer	Ø5/16"	4PCS
J		Bolt	5/16*250mm	4PCS

PART LIST

NO.	DRAWING	DESCRIPTION	Q'TY
1		High Pedestal	1
2		Mounting Bridge	2
3		Upper Post	2
4		Extension Block	2
6		Bottom Stretcher	1
7		Short Pedestal	2
8		Top Panel	1
9		Table Leaf	2

*Note:

1. Height of this table can be adjusted by removing or using extension blocks.
2. Leaves can not be switched, follow numbers on leaves and top when assemble.

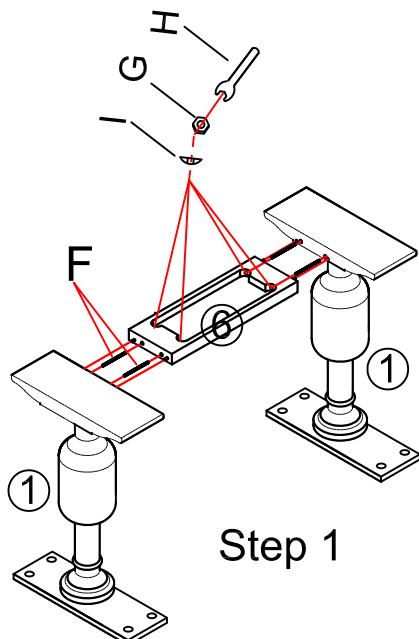

Step 1

Assembly steps with extension blocks-36" height:

Step 1: Attach bottom stretcher (6) between high pedestals (1).

ITEM: 6025-75206B-90 Ponte Friendship Table Base
6025-75206T-90 Ponte 60in Friendship Table Top w/ 2-12in Leaves

Thank you for purchasing this quality product. Be sure to unpack carefully looking for small parts which may have come loose during shipment. Read all instruction and study the drawing carefully before starting the assembly process.

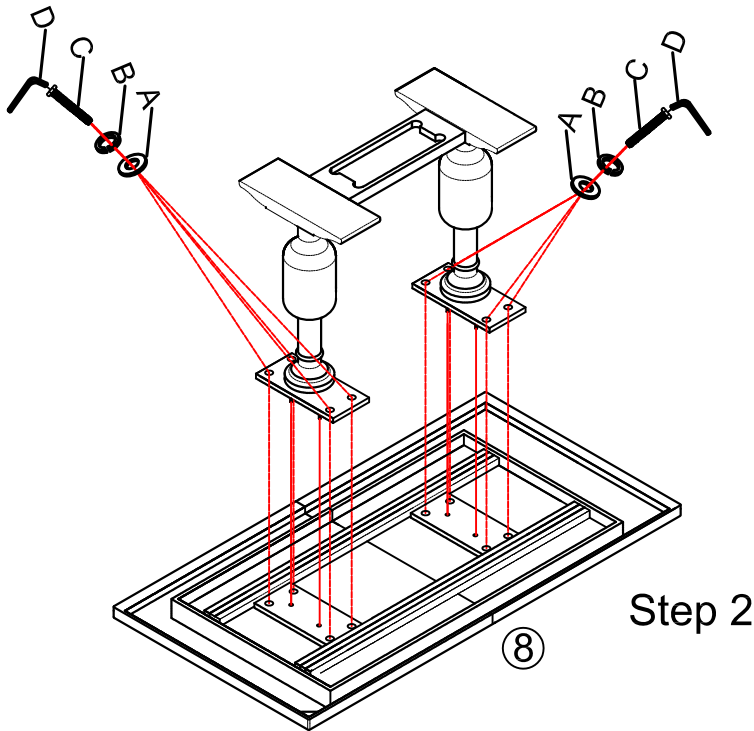

Step 2: Attach complete base to top panel (8).

Step 2

Assembly steps without extension blocks-30" height:

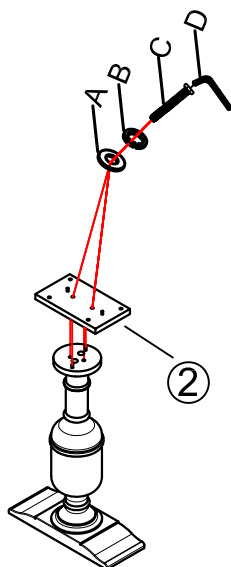

Step 1: Unscrew the assembly hardware as shown in diagram, then remove mounting bridge (2).

Step 1

ITEM: 6025-75206B-90 Ponte Friendship Table Base
6025-75206T-90 Ponte 60in Friendship Table Top w/ 2-12in Leaves

Thank you for purchasing this quality product. Be sure to unpack carefully looking for small parts which may have come loose during shipment. Read all instruction and study the drawing carefully before starting the assembly process.

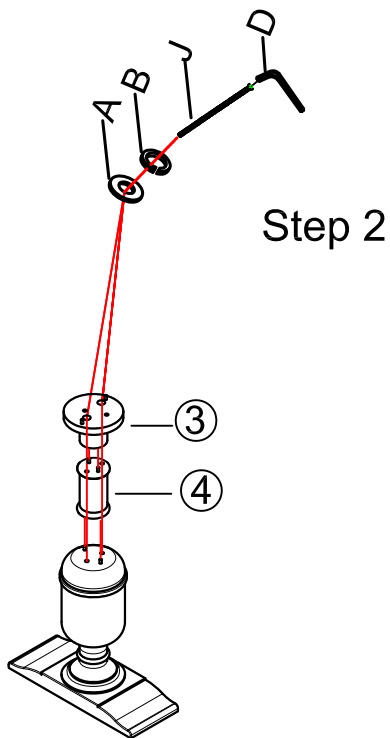

Step 2

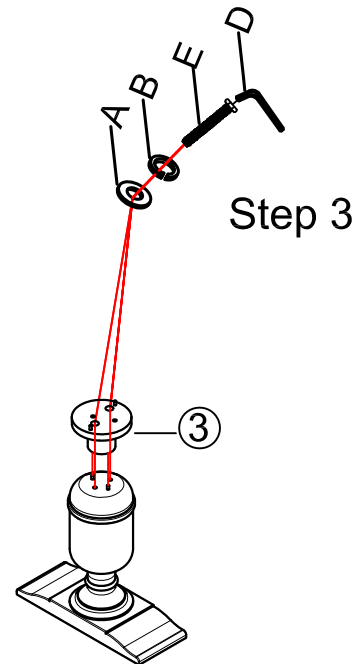

Step 3

Step 2: Unscrew the assembly hardware from pedestal as shown in this diagram, well remove extension blocks (4).

Step 3: Re-assemble upper posts (3) to pedestal.

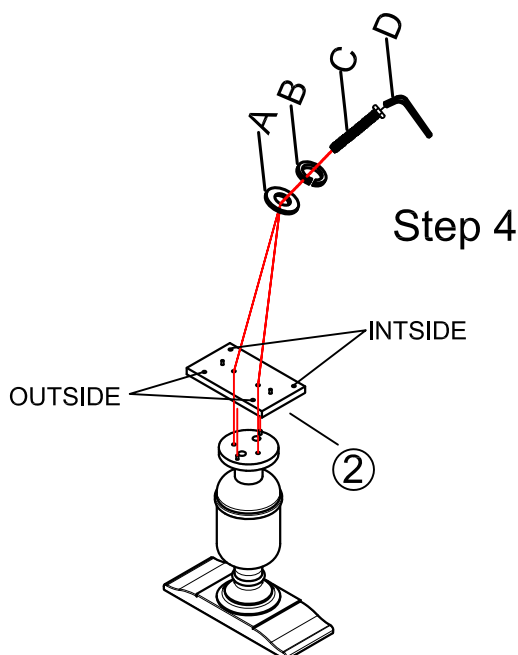

Step 4

Step 4: Attach mounting bridge (2). Please note pre-drilled holes with shorter distance should be located outside, pri-drilled holes with longer distance should be located inside.

ITEM: 6025-75206B-90 Ponte Friendship Table Base
6025-75206T-90 Ponte 60in Friendship Table Top w/ 2-12in Leaves

Thank you for purchasing this quality product. Be sure to unpack carefully looking for small parts which may have come loose during shipment. Read all instruction and study the drawing carefully before starting the assembly process.

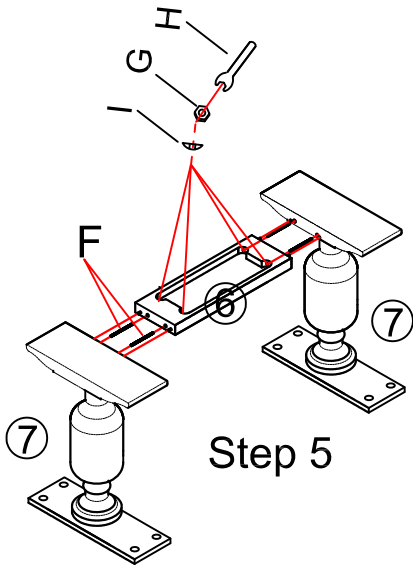

Step 5: Attach bottom stretcher (6) between short pedestals (7).

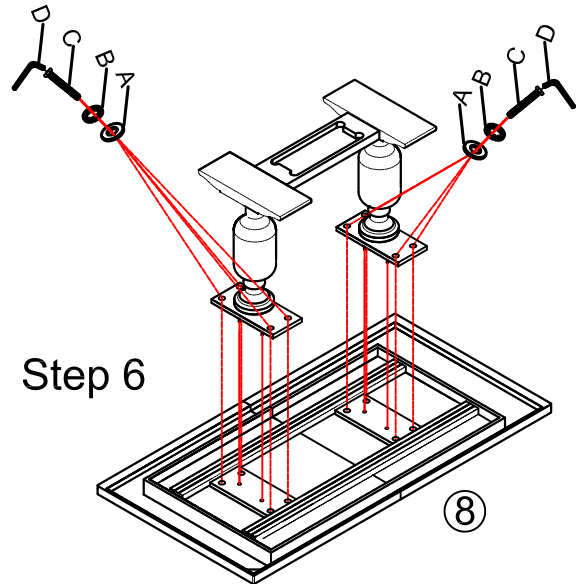

Step 6: Attach complete base to top panel (8).

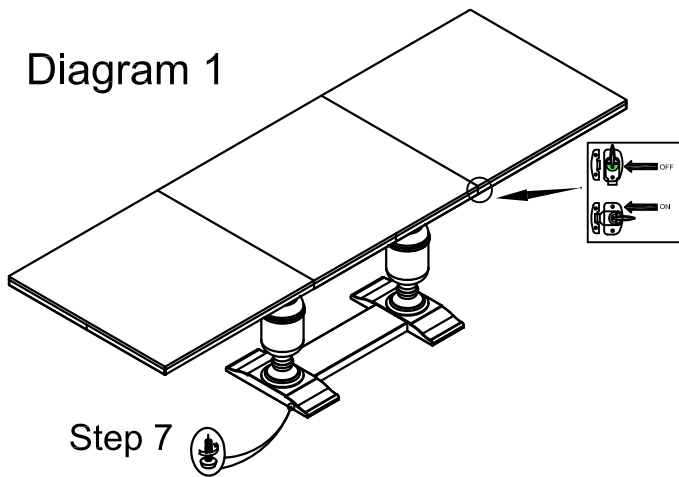

Step 7
Adjust Leveler if needed to level base on uneven floor.

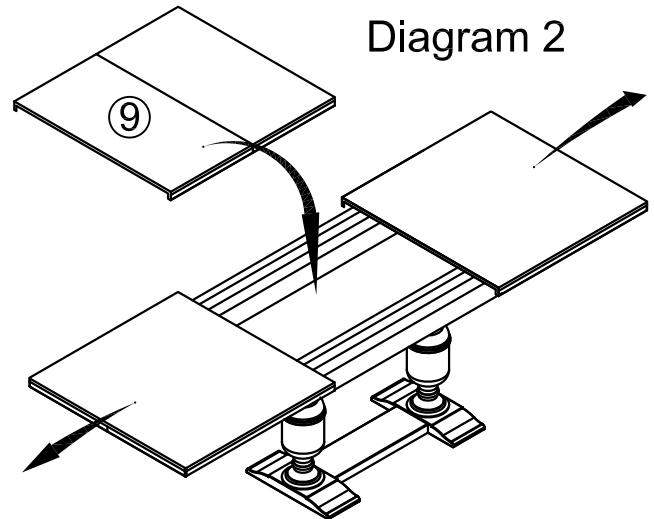

Instruction for table leaves:

1. There are latches at the bottom of table top, turn off the latches as shown in Diagram 1 .
2. Pull out table top as the arrow direction shown in Diagram 2 .
3. Place table leaves (9) between and push table tops together.
4. Turn on latches. (See Diagram 1)
5. Take opposite actions to remove table leaves.