











ASSEMBLY INSTRUCTION

ITEM: 6123-75906B-89 Display Cabinet Base
6123-75906T-89 Display Cabinet Top

Thank you for purchasing this quality product. Be sure to unpack carefully looking for small parts which may have come loose during shipment.

Read all instruction and study the drawing carefully before starting the assembly process.

HARDWARE PACK				
NO.	DRAWING	DESCRIPTION	SIZE	Q'TY
A		Allen Wrench	69*27.2*4mm	1 PC
B		Bolt	1/4*25mm	4 PCS
C		Lock Washer	1/4(6mm)	4 PCS
D		Flat Washer	1/4*16mm	4 PCS
E		Bolt	8#*11/4	2 PCS
F		Plastic Anchor		2 PCS
G		Anti - Tip Kit		1 PC

PARTS LIST			
NO.	DRAWING	DESCRIPTION	Q'TY
1		Cabinet Top	1 PC
2		Cabinet Base	1 PC
3		Glass Shelf	2 PCS

Assembly steps for connecting Cabinet Base and Top:

Place cabinet top (1) on top of cabinet base (2), then secure them via mending plates (H) by using bolts (B), lock washers (C), flat washers (D) and allen wrench (A).

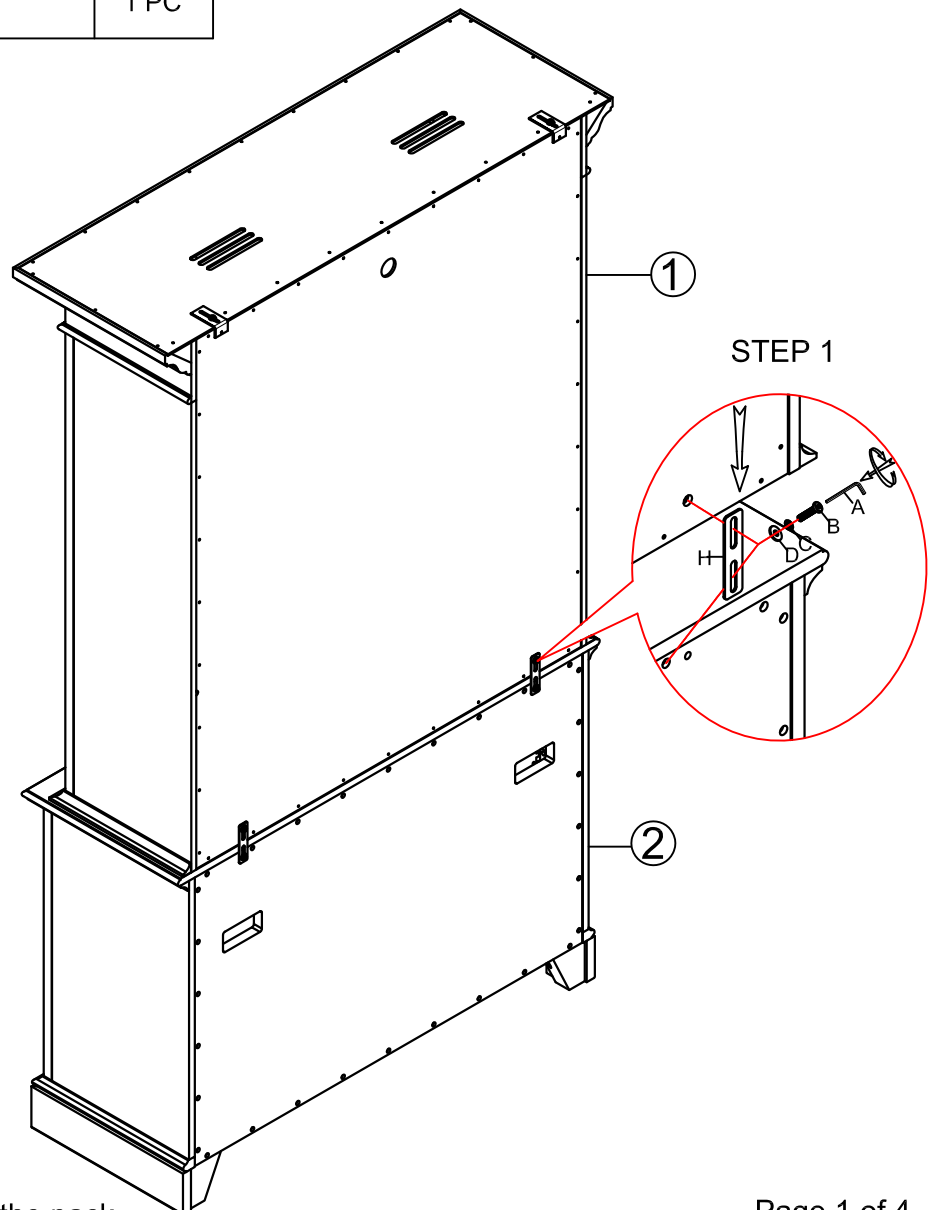

Note: Anti-tip kit restraint is provided.
Please follow the instructions enclosed with the pack.

ASSEMBLY INSTRUCTION

ITEM: 6123-75906B-89 Display Cabinet Base

6123-75906T-89 Display Cabinet Top

Thank you for purchasing this quality product. Be sure to unpack carefully looking for small parts which may have come loose during shipment.

Read all instruction and study the drawing carefully before starting the assembly process.

Anti-tip kit is included for use.
We recommend installing for
safety reason.

Tipping Restraint

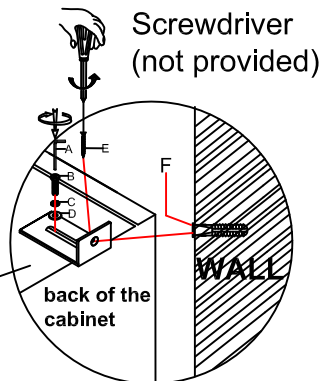
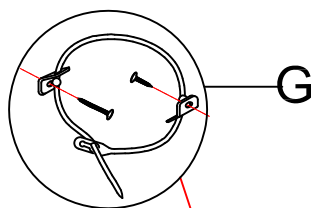

STEP 2

Mount the L-shape metal plate to top of the cabinet, then attach the cabinet to a wall.

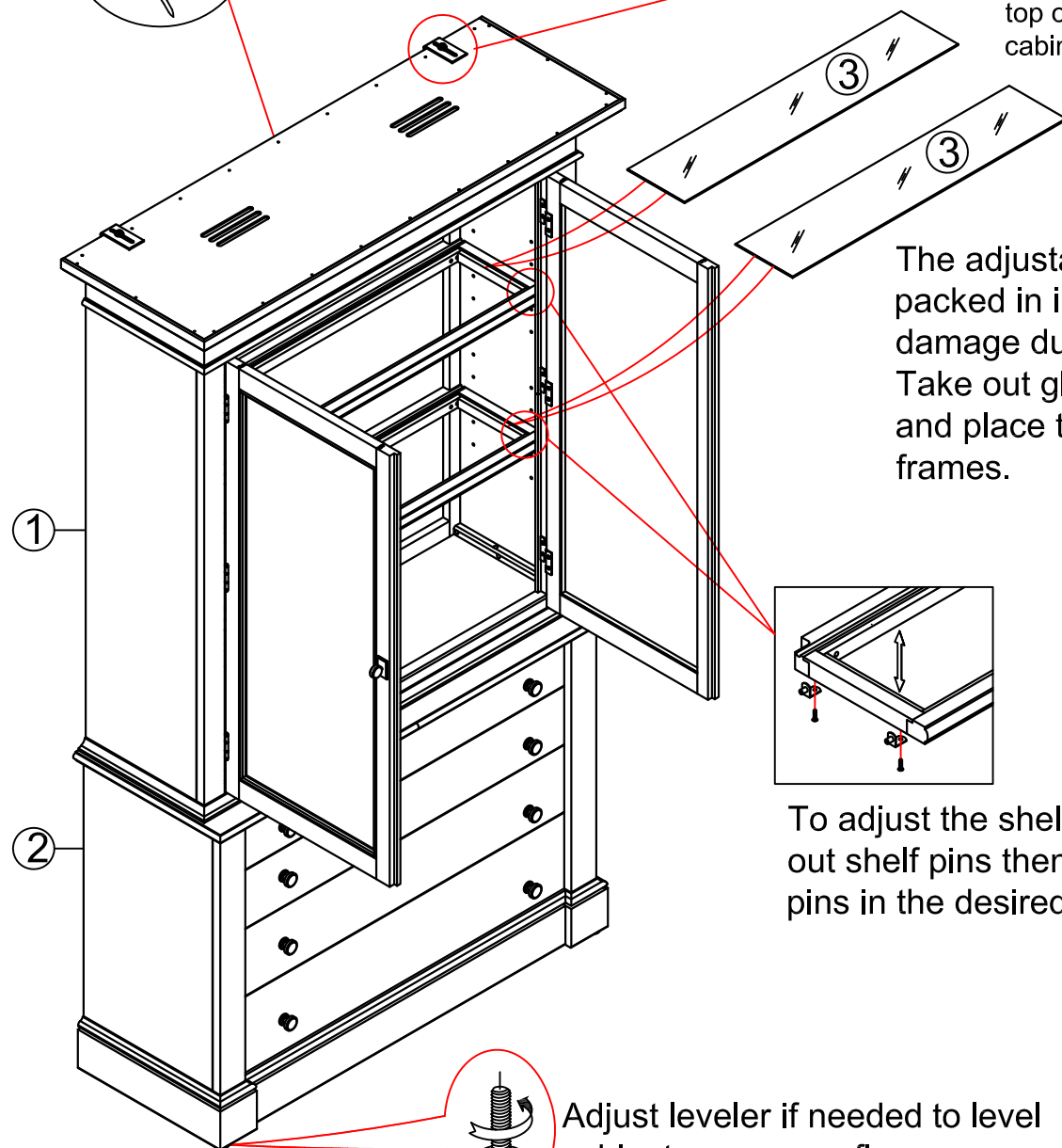

The adjustable glass shelves are packed in inner box to avoid damage during transit. Take out glass shelves from box and place them on wood shelf frames.

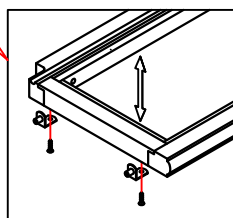

To adjust the shelf height, take out shelf pins then place shelf pins in the desired level.



Adjust leveler if needed to level cabinet on uneven floor.

ASSEMBLY INSTRUCTION

ITEM: 6123-75906B-89 Display Cabinet Base

6123-75906T-89 Display Cabinet Top

Thank you for purchasing this quality product. Be sure to unpack carefully looking for small parts which may have come loose during shipment.

Read all instruction and study the drawing carefully before starting the assembly process.

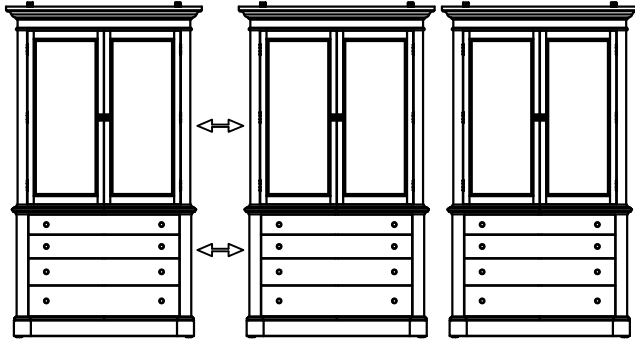

- A — male connector (of the power switch)
- B — female connector (of the power switch)
- C — male connector (of the puck light)
- D — female connector (of the puck light)
- E — male connector (of the power wire)
- F — female connector (of the power wire)

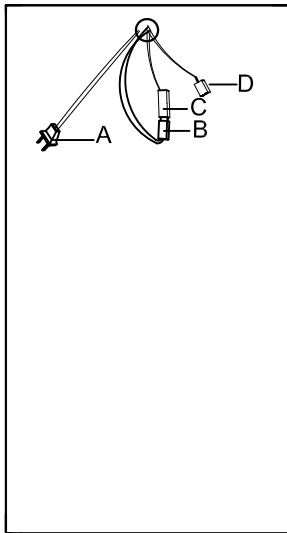
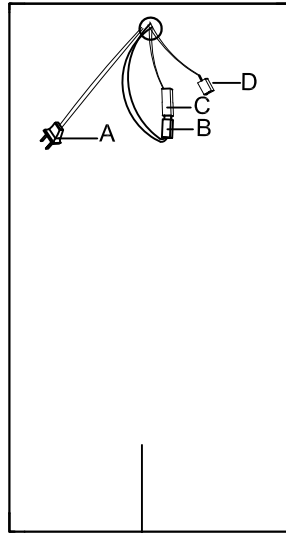
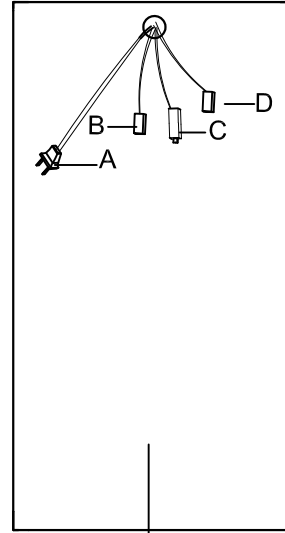

Diagram 1



#1



#2

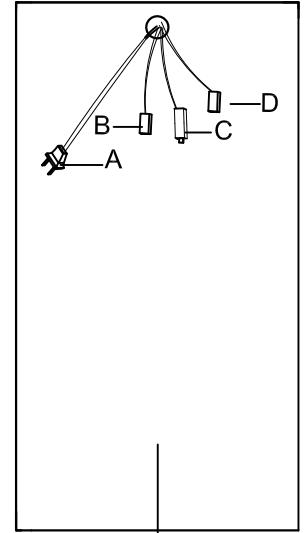

#3

Diagram 2

Assembly Steps

1. When each piece of cabinet is used alone, attach male connector of the power switch (A) to a wall plug. (See Diagram 1)
2. Touch dimmer is at the inside of right post.
3. If you want to bunch two or more cabinets together, place them all side by side in a desired location.
4. Leave male connector of the puck light (C) and female connector of power switch (B) for the first cabinet (#1) as it is. Keep male connector of the puck light (C) and female connector of power switch (B) off for the rest cabinets (#2, #3, and so on). (See Diagram 2)

ITEM: 6123-75906B-89 Display Cabinet Base

6123-75906T-89 Display Cabinet Top

Thank you for purchasing this quality product. Be sure to unpack carefully looking for small parts which may have come loose during shipment.

Read all instruction and study the drawing carefully before starting the assembly process.

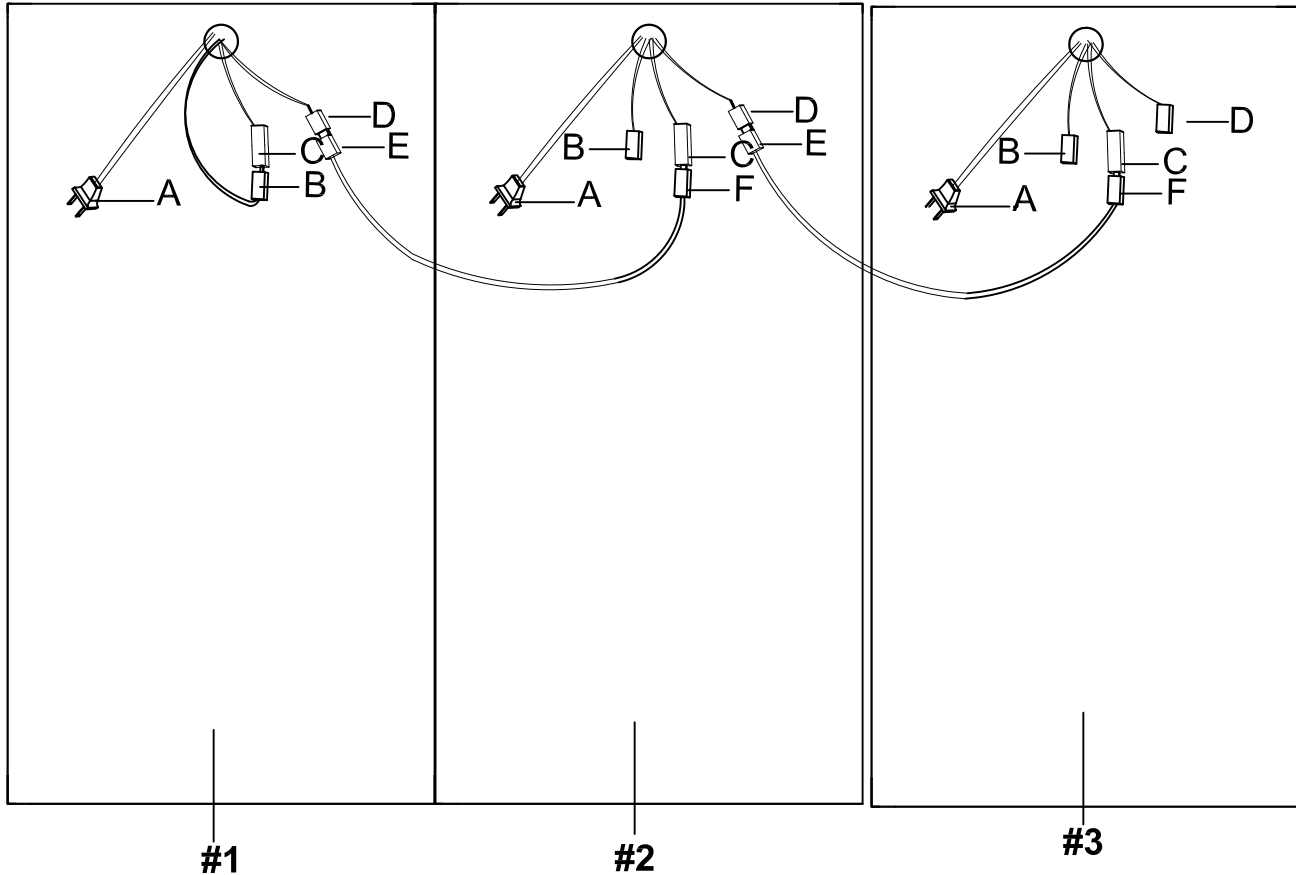
**Diagram 3****Assembly Steps**

5. Connect female connector of the puck light (D) (#1 cabinet) with male connector of power wire (E), then have female connector of power wire (F) connected to male connector of puck light (C) (the #2 cabinet). (See Diagram 3)
6. Repeat step 5 for the 3rd cabinet and the rest ones when more than two are bunched together till each one is connected.
7. Plug in male connector of power switch (A) (#1 cabinet).
8. Touch the dimmer of the #1 cabinet, all puck lights connecting together will be on at the same time.

Note: Anti-tip kit restraint is provided.
Please follow the instructions enclosed with the pack.