

PARTS LIST / LISTE DES PIÈCES / LISTA DE PIEZAS

PRODUCT NAME / NUMBER(S) : S862DJ-250/251/400

Description If Available / Needed : 5/0 Panel Headboard-Tête de grand lit en panneau-Cabecera estilo panel de 5/0
5/0 Panel FB & Slats-Pied de grand lit en panneau avec banc de lit-Pie de cama estilo panel con listones de 5/0
5/0 & 6/6 Set of Side Rails-Traverses de grand lit et très grand lit-Juego de travesaños laterales de cama de 5/0 y 6/6

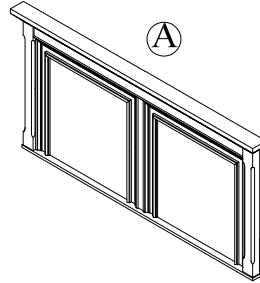
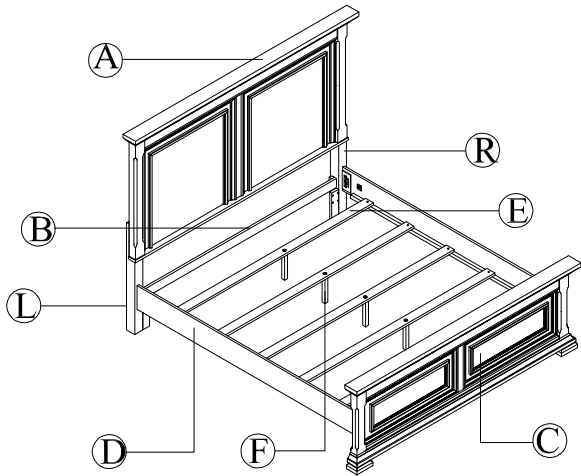

x1 Headboard panel
x1 Tête de lit
x1 Panel de la cabecera

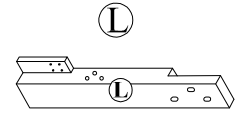

Left Leg *
Patte de gauche
Pata izquierda

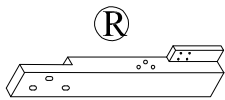

Right Leg *
Patte de droite
Pata derecha

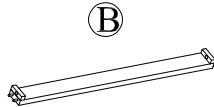

x1 Safety Rail *
x1 Garde-corps
x1 Baranda de seguridad

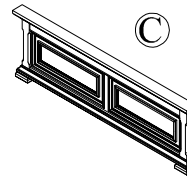

x1 Footboard Panel
x1 Pied de lit
x1 Panel de pie de cama



x2 Side Rail
x2 Traverse
x2 Travesaño lateral

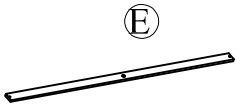

x5 Slats *
x5 Bancs de lit
x5 Listones

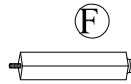

x5 Center leg *
x5 Pattes centrales
x5 Patas centrales

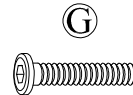

x8 Allen bolt Ø5/16"x50mm *
x8 Vis à tête creuse hexagonale Ø5/16"x50mm
x8 Perno Allen Ø5/16"x50mm



x16 Lock washer Ø5/16"x13 *
x16 Rondelle de blocage Ø5/16"x13
x16 Arandela de Seguridad Ø5/16"x13

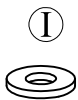

x8 Flat Washer Ø5/16"x19x1.5mm*
x8 Rondelle plate Ø5/16"x19x1.5mm
x8 Arandela plana Ø5/16"x19x1.5mm

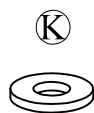

x8 Flat Washer Ø5/16"x16x1.5mm*
x8 Rondelle plate Ø5/16"x16x1.5mm
x8 Arandela plana Ø5/16"x16x1.5mm

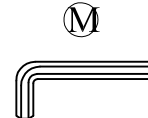

x1 Allen Key 4mm *
x1 Clé hexagonale 4mm
x1 Llave Allen 4mm

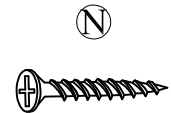

x10 Wood Screw #8x35mm *
x10 Vis à bois #8x35mm
x10 Tornillo para madera #8x35mm

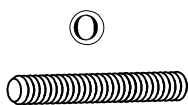

x8 Hanger Bolt Ø5/16"x88mm*
x8 Boulon-vis Ø5/16"x88mm
x8 Perno de suspensión Ø5/16"x88mm



x8 Hex nut *
x8 Écrou hexagonal
x8 Tuerca hexagonal

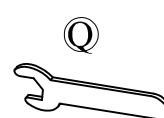

x1 Open Wrench 13mm *
x1 clé à fourche 13mm
x1 Llave de boca 13mm

* Replaceable Part

ASSEMBLY INSTRUCTION / NOTICE DE MONTAGE / INSTRUCCIONES DE MONTAJE

PRODUCT NAME / NUMBER(S) : S862DJ-250/251/400

Description If Available / Needed : 5/0 Panel Headboard-Tête de grand lit en panneau-Cabecera estilo panel de 5/0
5/0 Panel FB & Slats-Pied de grand lit en panneau avec banc de lit-Pie de cama estilo panel con listones de 5/0
5/0 & 6/6 Set of Side Rails-Traverses de grand lit et très grand lit-Juego de travesaños laterales de cama de 5/0 y 6/6

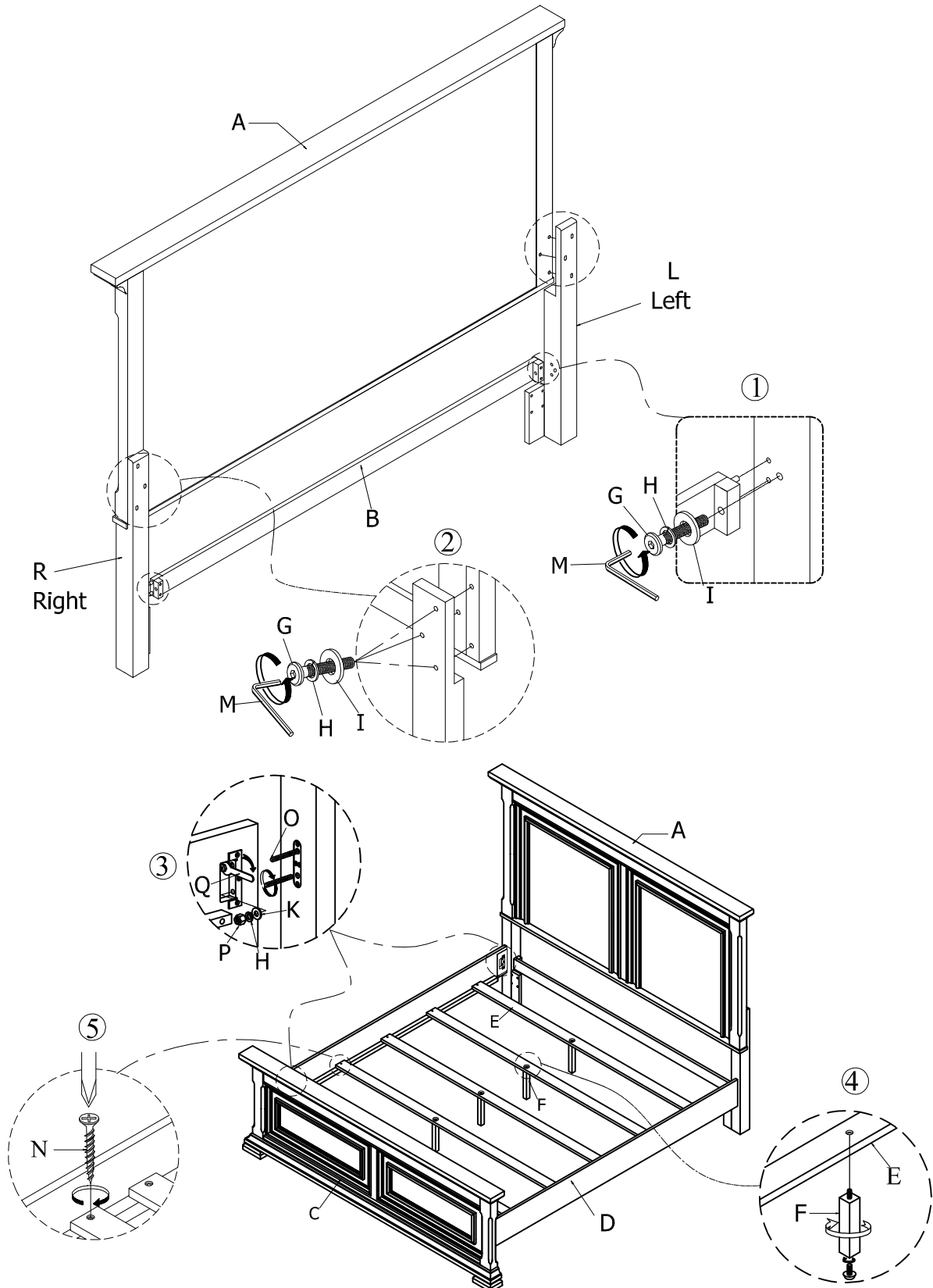

* Replaceable Part

REPLACEABLE PART / PARTIE REMPLACABLE / PARTE REEMPLAZABLE

PRODUCT NAME / NUMBER(S) : S862DJ-250/251/400

Description If Available / Needed : 5/0 Panel Headboard-Tête de grand lit en panneau-Cabecera estilo panel de 5/0
 5/0 Panel FB & Slats-Pied de grand lit en panneau avec banc de lit-Pie de cama estilo panel con listones de 5/0
 5/0 & 6/6 Set of Side Rails-Traverses de grand lit et très grand lit-Juego de travesaños laterales de cama de 5/0 y 6/6

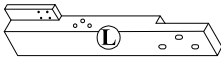
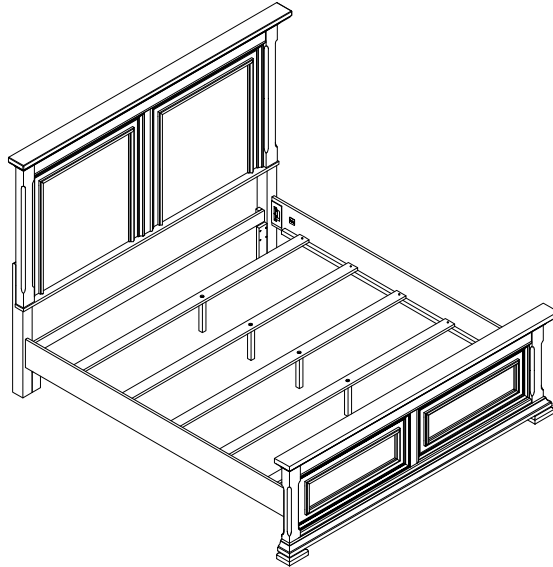

x1 RS862DJ-250-LEGL- Left Leg *
 Patte de gauche
 Pata izquierda

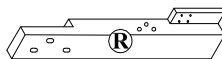

x1 RS862DJ-250 - LEGR- Right Leg *
 Patte de droite
 Pata derecha



x1 RS862DJ-250- RAIL- Safety Rail *
 Garde-corps
 Baranda de seguridad

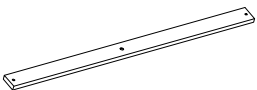

x5 RS862DJ-251- SLAT- Slat*
 Lattes
 Listones



x5 RS862DJ-251- SULEG-Center leg *
 Pattes centrales
 Patas centrales

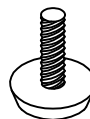

x5 RC-FG-BLACK- Black leveler*
 Patin réglable
 Nivelador ajustable

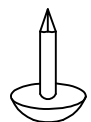

x4 RC-WH-NAIL-White plastic nail*
 Clou en plastique
 Clavo de plástico



x10 RS862DJ-251- SCREW- Screw *
 Vis à bois
 Tornillo para madera

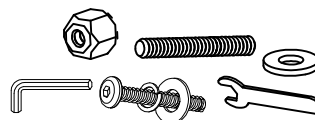

x1 RS862DJ-250- HWKIT-Hardware kit list *
 Liste des pièces de quincaillerie
 Lista del kit de materiales

* Replaceable Part