

- x1 Chair Back *
- x1 Dossier de chaise
- x1 Respaldo de silla

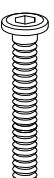

- x4 Allen bolt Ø5/16*3" *
- x4 Vis à tête creuse hexagonale Ø5/16*3"
- x4 Perno Allen Ø5/16*3"



- x10 Flat washer Ø5/16**19*2mm *
- x10 Rondelle plate Ø5/16**19*2mm
- x10 Arandela plana Ø5/16**19*2mm



- x1 Allen key M4 *
- x1 Clé hexagonale
- x1 Llave Allen

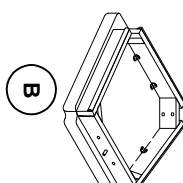

- x1 Seat Frame with Cushion *
- x1 Siege avec coussin
- x1 Cojín de asiento con cuadro del asiento

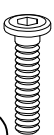

- x2 Allen bolt Ø5/16*1-1/2" *
- x2 Vis à tête creuse hexagonale Ø5/16*1-1/2"
- x2 Perno Allen Ø5/16*1-1/2"



- x4 Hex nut 12*12*6mm *
- x4 Ecrou hexagonal 12*12*6mm
- x4 Tuerca hexagona 2*12*6mm



- x10 Lock washer Ø5/16**14*2mm *
- x10 Rondelle de blocage Ø5/16**14*2mm
- x10 Arandela de Seguridad Ø5/16**14*2mm



- x1 Open wrench 12mm *
- x1 Clé à fourche 12mm
- x1 Llave de boca 12mm

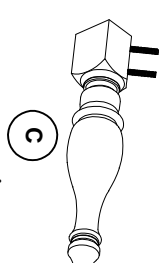

- x2 Front Leg *
- x2 Jambe avant
- x2 Pata delantera

* Replaceable Part

ASSEMBLY INSTRUCTION / NOTICE DE MONTAGE / INSTRUCCIONES DE MONTAJE

ITEM / NO D'ARTICLE / ARTICULO : S892-154

DESCRIPTION / DESCRIPCION : Side Chair / Chaise d'appoint / Silla

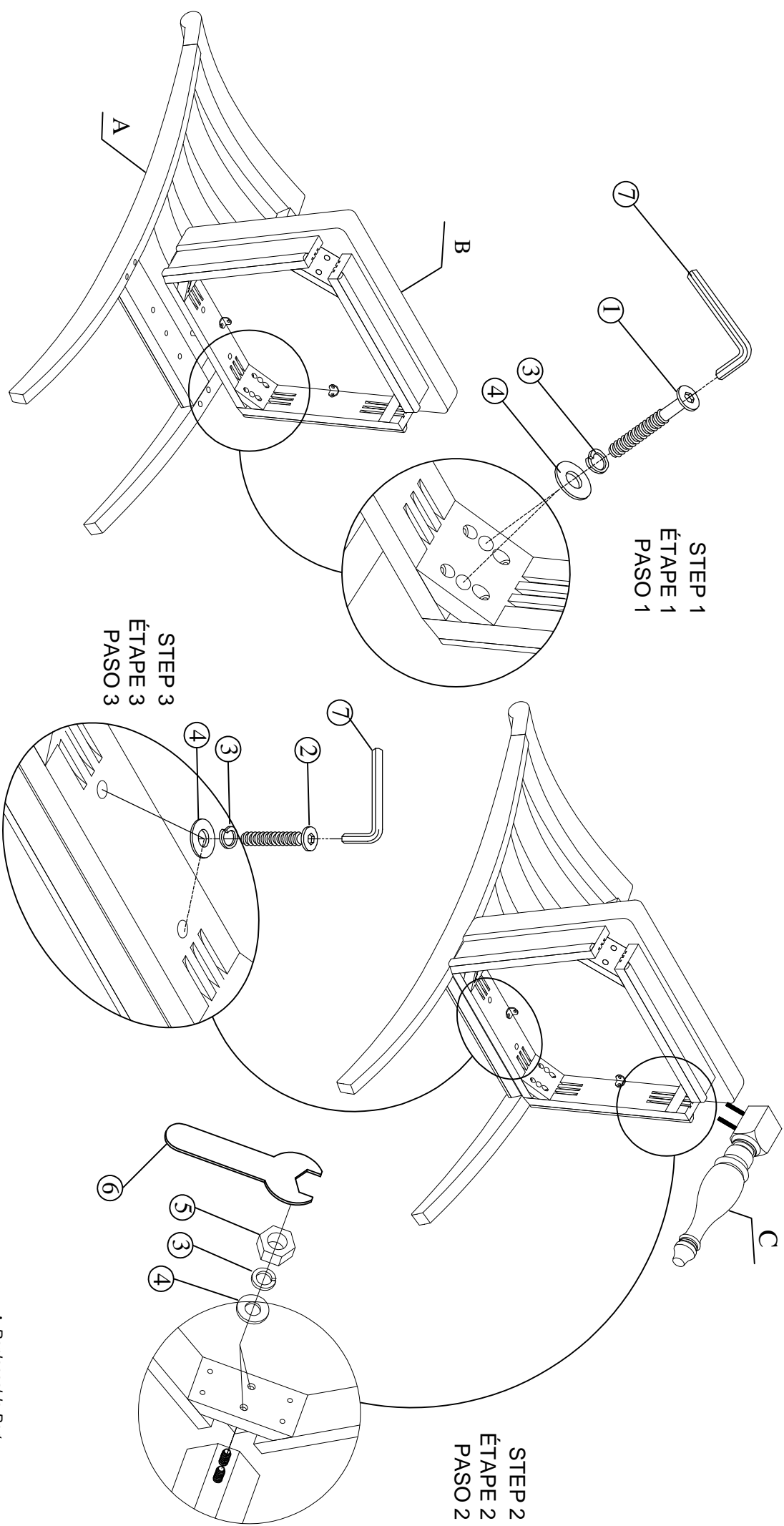

* Replaceable Part

REPLACEABLE PART / PARTIE REMPLACABLE / PARTE REEMPLAZABLE

ITEM / NO D'ARTICLE / ARTICULO : S892-154
DESCRIPTION / DESCRIPCION : Side Chair / Chaise d'appoint / Silla

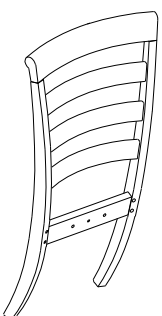
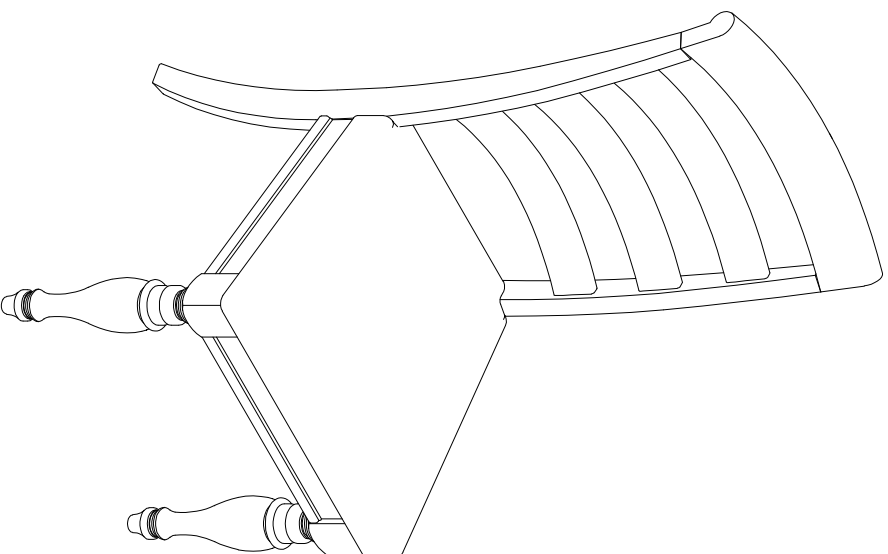

x1 RS892-154-BACK-Chair Back
Dossier de chaise
Respaldó de silla *

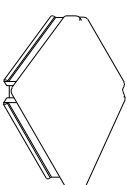

x1 RS892-154-FRAME-Seat Frame with Cushion
Siege avec coussin
Cojín de asiento con cuadro del asiento *

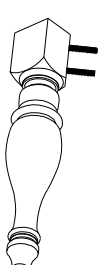

x2 RS892-154-LEG-Front Leg
Jambe avant
Pata delantera *

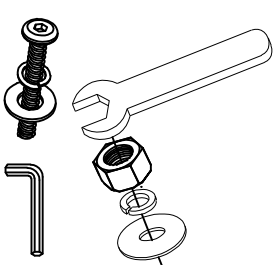

x1 RS892-154-HWKIT-Hardware kit list
Liste des pièces de quincailleries
Lista del kit de materiales *

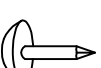

x4 RC-WH-NAIL - White Plastic nail
clou en plastique blanc
clavo de plástico blanco *

* Replaceable Part